



Instruction manual SWIRL propellers



Aérodrome de Villefranche Tarare (LFHV)
289 Avenue Odette & Edouard DURAND
69620 FRONTENAS - FRANCE
Phone: + 33 (0)4 74 72 12 69 - Fax: +33 (0)4 74 72 10 01
E-mail: contact@duc-helices.com - www.duc-helices.com

ISO 9001

BUREAU VERITAS
Certification



ISO 9001:2008 Certified Company
for its Quality System Management

Revision update

Date	Index	Object of modification
13/01/2010	-	creation
29/01/2016	G	Update
21/03/2017	H	New address



BUREAU VERITAS
Certification

DUC HELICES

AERODROME DE VILLEFRANCHE-TARARE
289 AVENUE ODETTE ET EDOUARD DURAND
69260 FRONTENAS - FRANCE

Bureau Veritas Certification France certifie que le système de management de l'organisme susmentionné a été audité et jugé conforme aux exigences de la norme :

Standard

ISO 9001 : 2008

Domaine d'activité

**CONCEPTION, FABRICATION D'HELICES, DE PALES
ET D'ACCESSOIRES AERONAUTIQUES.**

**DESIGN, MANUFACTURING OF AERONAUTICAL PROPELLERS,
BLADES AND ACCESSORIES.**

Date de début du cycle de certification : **14 décembre 2016**

Sous réserve du fonctionnement continu et satisfaisant du système de management de l'organisme, ce certificat est valable jusqu'au : **14 septembre 2018**

Date originale de certification : **22 février 2010**

Certificat n° : **FR027856-2** Date: **16 décembre 2016**

Affaire n° : **6330690**

Jacques Matillon - Directeur général

Adresse de l'organisme certificateur : Bureau Veritas Certification France
60, avenue du Général de Gaulle - Immeuble Le Guillaumet - 92046 Paris La Défense

Des informations supplémentaires concernant le périmètre de ce certificat ainsi que l'applicabilité des exigences du système de management peuvent être obtenues en consultant l'organisme.
Pour vérifier la validité de ce certificat, vous pouvez téléphoner au : + 33 (0)1 41 97 00 60.

This instruction manual is to be maintained throughout the life of the propeller.
He may have to evolve. The owner must check with the DUC Hélices company
the latest version being valid applicable to the propeller.

Identification

Date		Delivery note n°	
Owner		Engine/Gearbox ratio	
Aircraft		1 st recommended pitch blade angle	

Notes:

.....

.....

.....

.....

Performances

PITCH (°) at 20cm from the tip of the blade	TAKE-OFF DISTANCE (m)	CLIMB RATE (ft/min or m/s)	SLOW CRUISE (km/h & rpm)	VARIOUS CRUISE (km/h & rpm)	FAST CRUISE (km/h & rpm)	FULL THROTTLE VARIO 0 (km/h & rpm)

Notes (Date, Number of people, Weight, Weather, ...):

.....

.....

--	--	--	--	--	--	--

Notes (Date, Number of people, Weight, Weather, ...):

.....

.....

Summary

1.	Presentation of the SWIRL propeller	5
1.1.	Characteristics.....	5
1.2.	Advantages of the SWIRL airfoil	5
1.3.	Carbone Forgé® hub.....	5
1.4.	Option leading edge reinforced in Inconel	6
1.5.	Accessories	6
1.6.	Sales reference	6
2.	Installation precautions	6
3.	Applications.....	7
4.	Assembly instructions	8
4.1.	Components of the propeller.....	8
4.2.	List of tools required	8
4.3.	Assembly of the propeller on a worktable	8
4.4.	Installation of the propeller on the aircraft.....	9
4.5.	Adjusting the blade angle of the propeller.....	11
5.	Potential use & Maintenance of the propeller.....	12
5.1.	Potential use of the propeller: Unlimited	12
5.2.	Propeller maintenance schedule.....	12
5.3.	Regular maintenance (by the user).....	12
5.4.	General maintenance (by the user or an aeronautics workshop)	12
5.5.	Complete maintenance (by DUC Hélices company).....	13
6.	General terms of sale.....	13
6.1.	Ordering procedure	13
6.2.	Delivery	13
6.3.	Price	13
6.4.	Right of withdrawal	13
6.5.	Warranties	13
6.6.	Privacy Policy	13
6.7.	Litigation	13
7.	Appendix	14
7.1.	Dimension of the ROTAX 912S engine propeller-shaft	14
7.2.	Moment of inertia of the SWIRL propeller	14
7.3.	Operating limitation of the SWIRL propeller.....	14
7.4.	Identification marking of the propeller	15
7.5.	Technical folder of the CARBONE FORGÉ® propeller hub	16
7.6.	Technical folder of the Standard and Inconel SWIRL blade	17
7.1.	Declaration of conformance of the SWIRL propeller.....	19

1. Presentation of the SWIRL propeller

1.1. Characteristics

This propeller is available in:

- Two-blade, Three-blade

For engines with high power, its structure can be reinforced (SWIRL-R).

Available diameter:

- Ø59.8", Ø63.8", Ø65.4" and Ø68.1"
Ø1520, Ø1620, Ø1660 and Ø1730 mm

Weight:

- Two-blade Standard SWIRL Ø68.1" 6.00 lb 2.72 kg
- Three-blade Standard SWIRL Ø68.1" 8.00 lb 3.63 kg
- Two-blade Inconel SWIRL Ø68.1" 6.17 lb 2.85 kg
- Three-blade Inconel SWIRL Ø68.1" 8.27 lb 3.75 kg



1.2. Advantages of the SWIRL airfoil

The aerodynamic design of this propeller has been designed to have a "**constant speed**" effect.

The blades that are made from unidirectional layers of carbon fiber prepreg epoxy and their structure has been defined in order to obtain the maximum stresses in **torsion** and **bending**.

Therefore the effect of "constant speed" is not related to the deformation of the blade but its geometry and its particular profile.

Because of the **extra flat profile and low chord**, excellent performance is obtained in both:

- **Aerodynamic and acoustic performance, but also in fuel consumption.**

Thanks to the "constant speed" effect, there is **very small engine speed difference** between the aircraft on ground and in flight.

This propeller allows for excellent performance throughout the flight envelope including:

- **Improved efficiency at takeoff and climb rate due to higher engine speed**
- **Many cruise extension**
- **A high user comfort**

1.3. Carbone Forgé® hub



The hub of the propeller is manufactured using the patented Carbon Forged®. Made from layers of unidirectional carbon fiber epoxy prepreps, it saves weight while having outstanding mechanical strength.

1.4. Option leading edge reinforced in Inconel



The SWIRL blade is available in two leading edge versions:

- **Standard SWIRL or Inconel® SWIRL**

The Inconel SWIRL blade has the characteristic to be protected on the leading edge with Inconel® metallic reinforcement. This material is a superalloy containing mainly nickel, with a very high hardness of surface.

It increases the life of the propeller but also its performance due to a change in its inertial behavior.

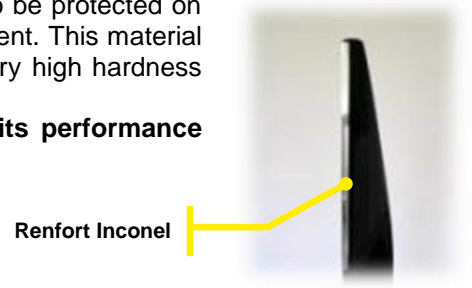

1.5. Accessories

- **Adaptor spacer in aluminum for mounting**

Adjust the placement of the propeller on the plane according to the position of the engine propeller-shaft and the engine cover.

- **Spinner in diameters Ø8.3" (Ø210mm) and Ø9.8" (Ø250mm)**
- **Adjusting tool for the setting of the pitch angle of the blades**
- **Cover protection of the blade**
- **Cleaning treatment for composite propellers**

Save money! A clean propeller is more efficient and decreases the fuel consumption.



1.6. Sales reference

Designation	Reference	Part number
Two-blade Inconel SWIRL propeller, Right	01-08-001	H-SW_2-D-I
Two-blade Inconel SWIRL propeller, Left	01-08-002	H-SW_2-G-I
Three-blade Inconel SWIRL propeller, Right	01-05-001	H-SW_3-D-I
Three-blade Inconel SWIRL propeller, Left	01-05-002	H-SW_3-G-I
Three-blade Inconel SWIRL-R propeller, Right	01-12-001	H-SW_3-D-R_I
Three-blade Inconel SWIRL-R propeller, Left	01-12-002	H-SW_3-G-R_I

Note:

Specify the flight regulation aircraft (E.g.: **Ultra-light, LSA...**) and diameter when ordering (E.g.: ref. 01-05-001/**1730**). For more information about the propeller marking, see section 7.4.

2. Installation precautions

WARNING Make sure the ignition is turned off before starting any type of operation on the propeller. Do not run the engine without propeller, engine damage will result.

IMPORTANT The blades of a propeller are part of a whole. **DO NOT INTERCHANGE** with other similar blades from propeller. The propeller blades are manufactured to their application. Their structure, weight and balance are different from a propeller to another.

The spinner is an important element for cooling the engine. The aircraft must not fly without a spinner. The Turbo version of the DUC spinners is particularly suitable for air-cooled engines (Ex: Jabiru ...). It limits variations in temperature between the engine at full takeoff and cruise flight, but also statically or on a taxiway. Fitting a different spinner will be an addendum to this manual approved by the DUC to confirm its compatibility with the mounting of the propeller.

On 2-stroke engines and other reduced engines with a power less than 65hp, the screws are capable of working in shear on the threaded part. For 4 stroke reduced engines (Ex: Rotax 912S) with a propeller fitted through holes, the screws should work on their smooth body (the value of a shear screw on the smooth part is 2 times higher than the threaded part). For other direct drive or reduced engine with a power higher than 65hp, it should add 3 indexing pawns Ø0.39" (Ø10mm) on the propeller-shaft (or adaptor spacer). The propeller is delivered with the appropriate screws. **The change of the screws is contrary to our recommendations unless validated by the manufacturers.**

WARRANTY CONDITIONS The user is still flying under its full responsibility (see 6.General terms of sale).

3. Applications

The DUC propellers have an **unlimited** flight potential in normal operation. To keep the unlimited potential, DUC Hélices defined a TBO (Time Between Overhaul) for a propeller depending on its engine. Refer to item 5. **Potential use & Maintenance** for more information.

Engine	Type	Gear box	Recommended propeller	Propeller diameter (inch)	Blade angle (°)	Blade angle allowed range(°)	TBO (hour)
3 AXIS - TRACTOR							
ROTAX 912	4-stroke	2.273	Three-blade SWIRL Std or Inconel, Right	Ø65.4"	20°	18° → 28°	800
		2.43	Three-blade SWIRL Std or Inconel, Right	Ø65.4"	23°	21° → 31°	800
ROTAX 912S	4-stroke	2.43	Three-blade SWIRL Std or Inconel, Right	Ø68.1"	24°	22° → 32°	800
ROTAX 914	4-stroke	2.43	Three-blade SWIRL-R Std or Inconel, Right	Ø68.1"	25°	23° → 33°	800
ROTAX 503	2-stroke	2.58	Two-blade SWIRL Standard or Inconel, Left	Ø65.4"	16°	14° → 24°	800
		2.62	Two-blade SWIRL Standard or Inconel, Left	Ø65.4"	18°	16° → 26°	800
		3	Three-blade SWIRL Std or Inconel, Left	Ø65.4"	15°	13° → 23°	800
ROTAX 582	2-stroke	2.58	Two-blade SWIRL Standard or Inconel, Left	Ø65.4"	18°	16° → 26°	800
		2.62	Two-blade SWIRL Standard or Inconel, Left	Ø65.4"	20°	18° → 28°	800
		3	Three-blade SWIRL Std or Inconel, Left	Ø68.1"	17°	15° → 25°	800
JABIRU 2200	4-stroke	-	Three-blade SWIRL Std or Inconel, Right	Ø59.8"	16°	14° → 24°	600
JABIRU 3300	4-stroke	-	Three-blade SWIRL-R Std or Inconel, Right	Ø63.8"	17°	15° → 25°	600
HKS	4-stroke	2.58	Two-blade SWIRL Standard or Inconel, Left	Ø65.4" à 68.1"	On request	On request	800
CONTINENTAL O-200 LYCOMING O-235	4-stroke	-	Three-blade SWIRL-R Std or Inconel, Right	Ø65.4"	20°	18° → 28°	600
VOLKSWAGEN	4-stroke	-	Three-blade SWIRL Std or Inconel, Right or Left according to the engine adaptation	Ø59.8" à 63.8"	On request	On request	600
3 AXIS – PUSHER							
ROTAX 912	4-stroke	2.273	Three-blade SWIRL Std or Inconel, Left	Ø68.1"	20°	18° → 28°	800
		2.43	Three-blade SWIRL Std or Inconel, Left	Ø68.1"	20°	18° → 28°	800
ROTAX 912S	4-stroke	2.43	Three-blade SWIRL Std or Inconel, Left	Ø68.1"	24°	22° → 32°	800
ROTAX 503	2-stroke	2.58	Two-blade SWIRL Std or Inconel, Right	Ø68.1"	13°	11° → 21°	800
		2.62	Two-blade SWIRL Std or Inconel, Right	Ø68.1"	16°	14° → 24°	800
		3	Three-blade SWIRL Std or Inconel, Right	Ø68.1"	15°	13° → 23°	800
ROTAX 582	2-stroke	2.58	Two-blade SWIRL Std or Inconel, Right	Ø68.1"	15°	13° → 23°	800
		2.62	Two-blade SWIRL Std or Inconel, Right	Ø68.1"	18°	16° → 26°	800
		3	Three-blade SWIRL Std or Inconel, Right	Ø68.1"	17°	15° → 25°	800
AUTOGYRO & TRIKES – PUSHER							
ROTAX 503	2-stroke	2.58	Two-blade SWIRL Std or Inconel, Right	Ø68.1"	16°	14° → 24°	800
ROTAX 582	2-stroke	2.58	Two-blade SWIRL Std or Inconel, Right	Ø68.1"	18°	16° → 26°	800
OTHER APPLICATIONS							
For all other applications, thank you to contact the DUC Hélices company to study the possibility of adapting the SWIRL propeller.							

*Ø68.1" = Ø1730mm; Ø65.4" = Ø1660mm; Ø63.8" = Ø1620mm; Ø59.8" = Ø1520mm

Note:

The values of the pitch angle are associated with the engine. This setting should be adjusted according to the aircraft (see **INDICATIONS FOR TESTING**).

For proper use of the propeller, refer to item 5. **Potential use & Maintenance**.

4. Assembly instructions

The assembly of the SWIRL propeller is explained below. The procedure is the same for two-blade and three-blade SWIRL propellers. For further information, contact the DUC Hélices company.

4.1. Components of the propeller

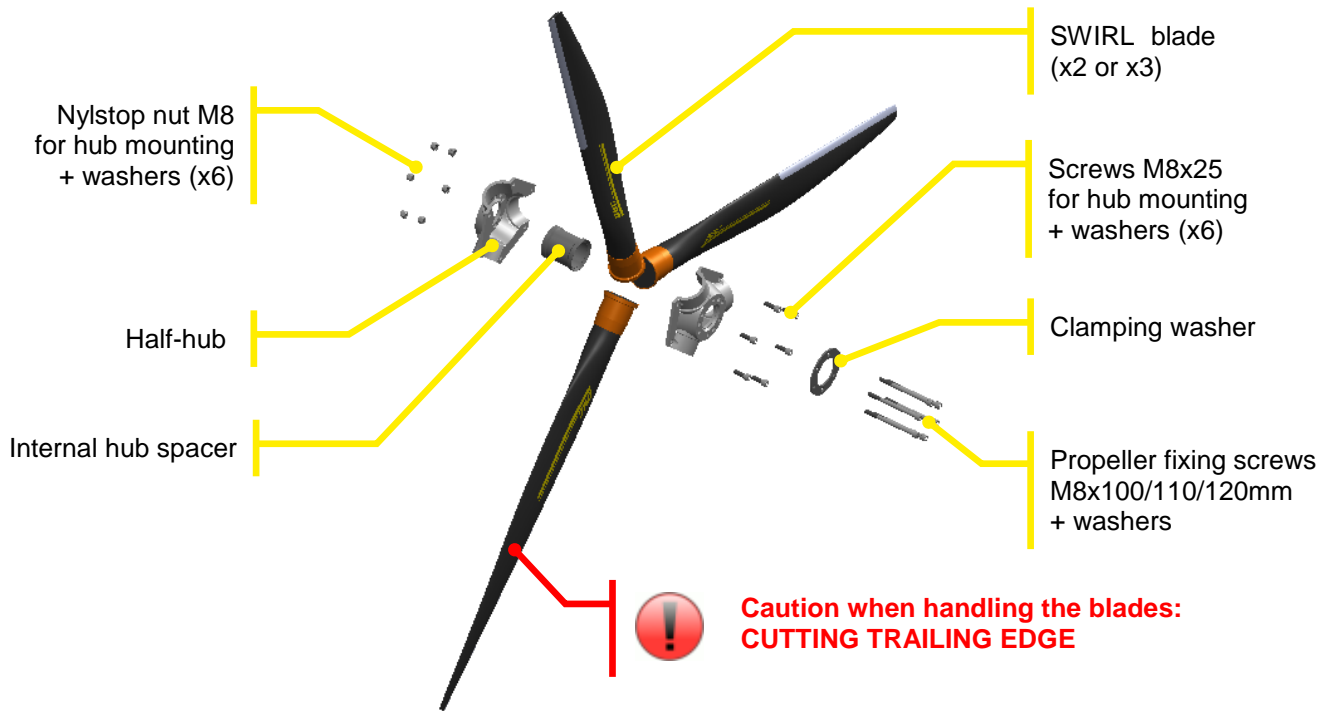

4.2. List of tools required

M8 Torque Hex key (for tightening at 25 Nm); M8 Torque Wrench (for tightening at 25 Nm); Inclinator (pitch adjusting tool); Plastic mallet; Torque Screwdriver (Tightening: 4 Nm)

4.3. Assembly of the propeller on a worktable

STEP 1

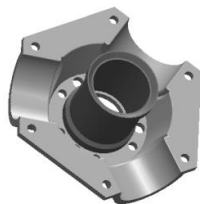

Place a half hub with its internal spacer in center on a worktable.

STEP 2



Place the blades in their compartment by pulling them outward. **Direct the DUC sticker facing you.**

STEP 3



Place the second half-hub on the whole engaging the blade foots.

STEP 4

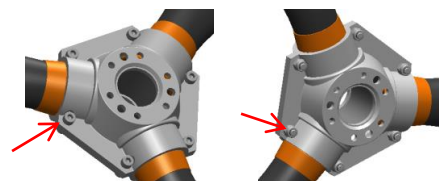

From the front of the hub, set up the 6 short screws M8x25mm of the hub assembly.

At the rear, place the Nylstop nuts M8 and tighten moderately.

STEP 5

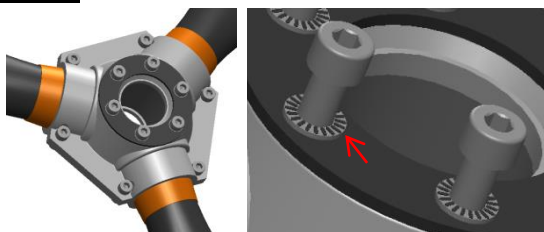

Position the clamping washer on the front of the propeller hub (same side as the **DU**C logo sticker), then place the 6 large screws M8x100/110/120mm with their washers.

The washer grooves must be in contact with the head of the screw.

4.4. Installation of the propeller on the aircraft

According your configuration, an adaptor spacer can be installed on the propeller-shaft of your engine.

STEP 6

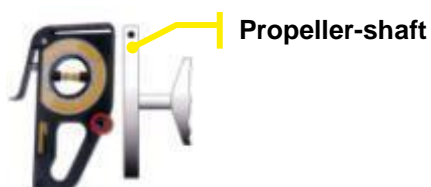

Place your aircraft so that the propeller shaft plate is perfectly vertical.

Check with the level of the adjustment tool (90°).

If unable to change the longitudinal axis of the aircraft, raising the value of the X angle propeller shaft plate to subtract the value of the blade angle to be resolved.

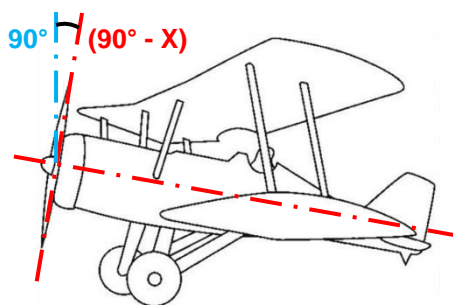

STEP 7

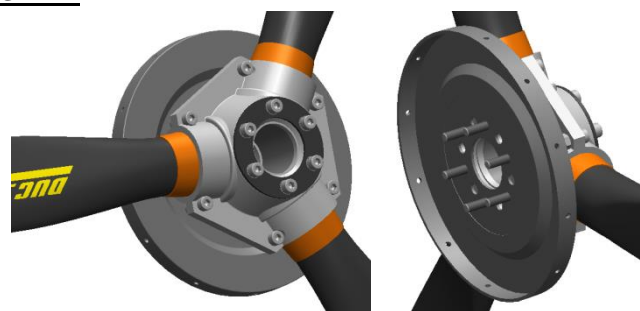

From the back, position the spinner mounting plate according the screws.

Be careful to respect the direction of the plate.

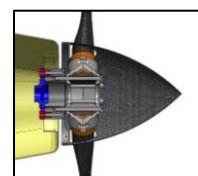

STEP 8

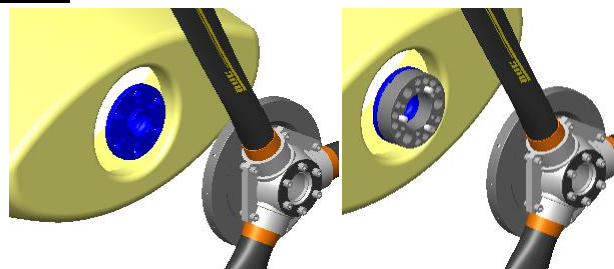

Install the whole stack on the propeller-shaft (or on the corresponding adaptor spacer).
Tighten moderately.

STEP 9

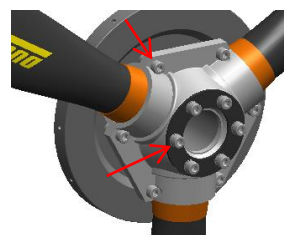

Slightly loosen the screws so that each blade can rotate in its compartment.

STEP 10



Adjust the pitch angle of the blades with the adjusting tool. See the item **4.5. Adjusting the blade angle of the propeller.**

STEP 11

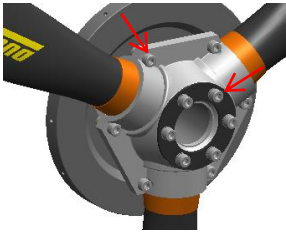

When the blades are set at the appropriate angle of installing, tighten all the screws to a **torque of 25Nm (2.5kg/m; 221lbs/in)**.

SCREWS TIGHTENING TORQUE = 25Nm (2.5kg/m; 221lbs/in)

The tightening of the propeller must be done in two steps:
 1st approach to close the screws tightening moderately
 2nd tightening with a torque wrench

STEP 12



Once all the settings of the propeller were made, mount the spinner of the propeller by tightening the screws to **4Nm (0.4 kg/m; 35lbs/in)** with the appropriate tools.

At this point, the propeller SWIRL is ready for initial testing.

CAUTION

After a 1 hour operation following the installation or modification of the assembly, tighten again your propeller according the assembly instructions.
 A painted mark of the screws can be done to allow a visual check of proper tightening screws.



At this point, the SWIRL propeller is ready for first tests.

The user must perform the appropriate regulations procedures to change the propeller in accordance with applicable regulations of the aircraft.

PRECAUTIONS

If you notice any abnormal installation or operation, do not undertake the flight and immediately contact the DUC Hélices Company.



Being aware of potential risks during assembly and initial testing of the propeller. Stay focused, attentive and vigilant to your surroundings. Recheck several points to be observed. Maintaining high safety clearance during the set operation.

The accessories of assembly and the propeller must be mounted according to technical documents from the DUC Hélices Company.

The non-compliance of these data would release the liability of the company (see **6.General terms of sale**).

INDICATIONS FOR TESTING



The tests are important. It is normal to make several adjustments successive alternating ground flight tests.

PRELIMINARY TEST to secure the first flight (Test Ground): Hold your aircraft, brakes locked. Follow the manufacturer's recommendations for safety on.

Start the engine running, warm it.

Full throttle, the engine must be **at least 85%** of the recommended maximum engine speed in flight by the manufacturer. **If this is not the case, adjust the blade angle of blades.** Add the angle to reduce the engine speed (and vice versa). 1 ° pitch affects about 200 rpm on the engine speed.

TEST VALIDATION properly adjusted the pitch of the blades (Flight Test): Check all tightening. Take off and place the aircraft in steady horizontal flight, vario zero.

For takeoff, it is not recommended to throttle, brake and then release the brakes. You have to put the throttle gradually, brake released. The propeller has a constant speed effect, so this second way avoids cavitation takeoff. In addition, this method allows shorter takeoffs.

Full throttle, the maximum engine speed recommended by the manufacturer must be reached **but not exceeded.** **If this is not the case, adjust the pitch of the blades.** Add the angle to reduce the engine speed (and vice versa). 1 ° pitch affects about 200 rpm on the engine speed.

4.5. Adjusting the blade angle of the propeller

Above all, the blade must be set to a horizontal position with its leading edge upward.

The calibration is done with the adjustment tool plated against the intrados at **20cm (7.9") from the blade tip**. The angle of attack is formed by the vertical plane and the intrados of the blade.

To do this, place your aircraft horizontally so that the propeller-shaft is perfectly vertical.

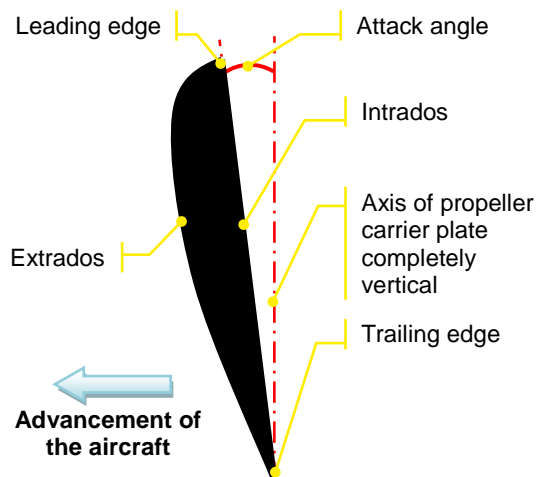
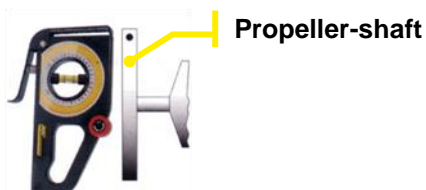

Check with the level of the adjustment tool (90°).

If unable to change the longitudinal axis of the aircraft, raising the value of the **X** angle propeller shaft plate to **subtract** the value of the blade angle to be resolved.

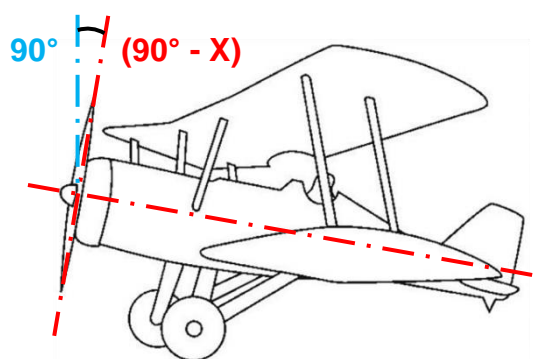

Method:

- 1) Fixing screws of the propeller and of the hub slightly unscrewed, horizontal blade, leading edge upwards, place the adjusting tool at 20cm (7.9") from the tip of the blade, intrados side (flat) of the blade, handle down (see the picture below).
- 2) Set the desired value (recalculated if required on the inclination of the aircraft) on the tool.
- 3) Using a mallet, lightly tap on the foot blade to rotate the blade in the desired direction.
- 4) Once the desired pitch angle obtained, perform the same operation on each of the other blades. Remove the tool and tight the fixing screws of the propeller to a **torque of 25Nm (2.5 kg/m; 221lbs/in)**.

SCREWS TIGHTENING TORQUE = 25Nm (2.5kg/m; 221lbs/in)

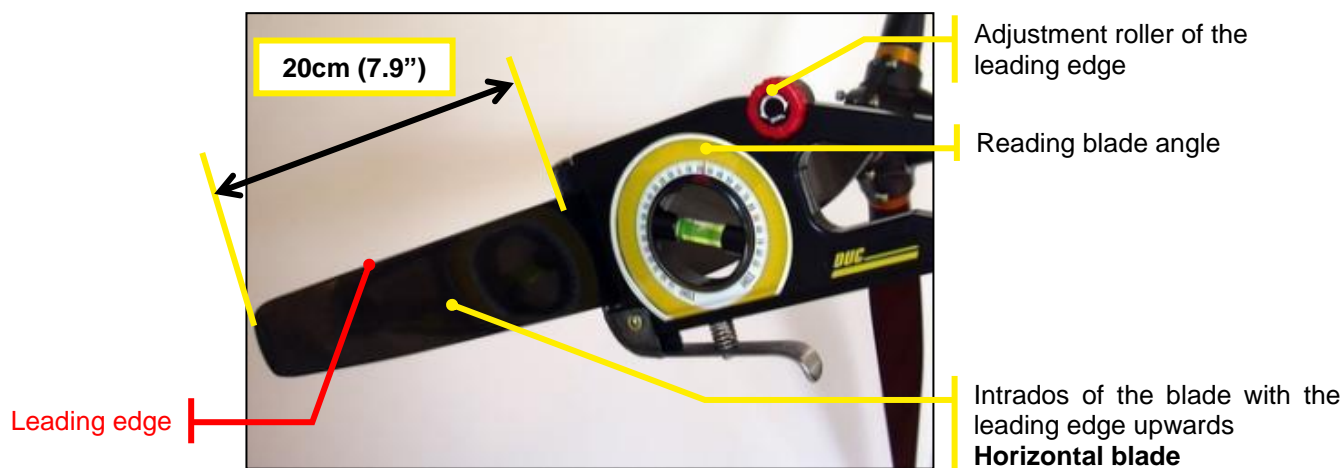

The accuracy of the adjusting tool is 0.2° . It is defined by the tolerance of the visual positioning of the level bubble between the two lines.

5. Potential use & Maintenance of the propeller

5.1. Potential use of the propeller: **Unlimited**

The DUC propellers have an unlimited flight potential in normal operation.

To keep the unlimited potential, DUC Hélices has defined a TBO (Time Between Overhaul) for a propeller depending on its engine. This TBO according the engine is indicated in this manual (see 3. **Applications**). In all cases, it should not exceed 5 years. When more intensive use (flight school ...), the value of the TBO can be doubled maintaining control at least every 2 years.

To achieve this, we propose to return the propeller to make a full control and ensure its proper use. If no critical anomaly is detected, it is again credited with the same TBO and is returned to you.

As a reminder, there is no imperative logbook. But know that this control is offered as a service to our customers for continuing airworthiness and there is no obligation. In fact, security will not be affected.

The deliveries costs of sending and returning will be payable by the customer.

5.2. Propeller maintenance schedule

Type	Actor	Frequency
Regular	User	Each pre-flight
General	user or an aeronautics workshop	Every 100 hours or annually
Complete	DUC Hélices company	Each TBO

5.3. Regular maintenance (by the user)

For a safety use of the SWIRL propeller, it is necessary that the user performs regular maintenance to detect any abnormalities. This maintenance is usually just a simple check.

Frequency of checking: Each pre-flight

Control methods: Visual inspection & Manual handling

Checkpoints:

- Fixation of the propeller:

Manually maintaining the tip of a blade of the propeller, shake it firmly to feel if a too much clearance appears in the setting of the propeller.

- Degradation of material:

Check visually the entire propeller without dismantling (blade root, Inconel leading edge, surface of the blade, spinner, hub, etc.)

- Fixation of the spinner: Check visually the fixation screws of the spinner. A marking paint can be made between each screw and spinner to have a means of visual inspection of proper tightening the screws.

Possible problems:

- Too much clearance in the propeller fixation

- Surface degradation due to dirt or impact / Crack apparent

Corrective actions (depending on the importance):

1. Clean the propeller with the DUC cleaning treatment DUC (ref. 01-80-003)

2. Perform a repair with the DUC repair kit (ref. 01-80-004)

3. Tighten the screws to proper torque

4. Replace(s) damage component(s)

5. Contact DUC Hélices to define a solution

5.4. General maintenance (by the user or an aeronautics workshop)

A general maintenance by the user or an aeronautics workshop must be made at lower frequency.

Frequency of checking: Every 100 hours or annually

Control methods: Visual inspection & Torque wrench

Checkpoints:

- Fixation of the propeller: By removing the spinner of the propeller, check the proper tightening of the screws to the wrench. These screws of the hub should be tightened to proper torque, defined in the installation instructions attached.

A marking paint of all the screw/washer/hub after tightening can be done to help make a visual check outside of the general maintenance.

- Degradation of material: Check visually the entire propeller (blade root, Inconel leading edge, surface of the blade, spinner, hub, etc.)

Possible problems:

- Too much clearance in the propeller fixation

- Surface degradation due to dirt or impact / Crack apparent

Corrective actions (depending on the importance):

1. Clean the propeller with the DUC cleaning treatment DUC (ref. 01-80-003)

2. Perform a repair with the DUC repair kit (ref. 01-80-004)

3. Tighten the screws to proper torque

4. Replace(s) damage component(s)

5. Contact DUC Hélices to define a solution

5.5. Complete maintenance (by DUC Hélices company)

Upon reaching the TBO (potential flight time between overhaul) defined by DUC Hélices, we recommend to return the propeller to the corporation for a full inspection of all components of the propeller.

See section 3. **Applications** for the potential value of an hour's flight engine.

The possible degradation of the propeller components may vary depending on the location of use.

6. General terms of sale

6.1. Ordering procedure

Orders placed by fax, by phone or e-mail engage the customer upon receipt by our Services and the Regulations.

6.2. Delivery

DUC Hélices Company agrees to make every effort to deliver the order within the shortest time, and the receipt of the order together with the Regulation. The delivery times indicated on the order are only indicative and the possible delays do not entitle the buyer to cancel the sale, to refuse the goods or claim damages. Any claim for non-compliance or failure will be sent within one week following the date of receipt of order.

The DUC Hélices Company is released from its obligation to deliver for all fortuitous events or force majeure. As an indication, the total or partial strikes, floods, fires are cases of force majeure. The transfer of ownership of goods supplied or delivered is suspended until full payment of price by the customer and without affecting the transfer of risk.

6.3. Price

The DUC Hélices Company may change its prices at any time.

The customer agrees to pay the purchase price in effect at the time of order entry. Regulation Order is payable in advance in one payment when sending the DUC Hélices Company purchase order.

6.4. Right of withdrawal

Under Article L121-16 of the Consumer Code, the customer shall have seven clear days after the delivery of his order to return the products to the DUC Hélices Company for exchange or refund, without penalties except for the return costs. Returned products must not have suffered modification, damage consequence of shock or improper use and be packaged in original packaging. Goods shipped with postage due will not be accepted.

6.5. Warranties

The DUC Hélices Company's products must be installed and used in accordance with instruction manuals provided. No changes can be made without the prior approval of the DUC Hélices company. The failure of these data releases any liability of the DUC Hélices Company and makes non-warranty the considered products.

The user is still flying under its sole responsibility.

The legal guarantee of industrial products is six months or during the TBO duration of the propeller (depends on which engine it is installed) against defects and hidden defects. See the section 3. **Applications** to determine the potential value of an hour's flight engine.

DUC Hélices Company guarantees its product defect under normal use in the manner described below: If the customer finds a defect, he must report it immediately to the DUC Hélices and features of one months after its purchase to return to society DUC Hélices, all structural defects will snuff into account (except for damage result of incorrect operation, shock, injury, impairment or neglect, water or generally inappropriate use by the engine type, power, speed and gear). To qualify for this warranty, the customer must send at its expense within one month after its purchase to be returned to society with DUC Hélices delivery order attached to the product. In return, the DUC Hélices Company takes no responsibility for damage or loss during transit due to improper or inadequate packaging. The company DUC Propellers then returned at his expense to the customer at the address on the delivery note, an identical or equivalent.

In addition to these guarantees, the company DUC Hélices provides no other warranties.

6.6. Privacy Policy

All the data you entrust to us are able to process your orders. Under Law No. 78-17 of January 6, 1978 relating to data, files and freedoms you have with the customer service company DUC Hélices right to access, review, correct, correct and delete data you have provided.

6.7. Litigation

Any order placed convincing the customer, without any restriction, the General Conditions of sale of the DUC Hélices Company. Any dispute concerning the sale (price, GTS, product ...) will be subject to French law before the Tribunal de Commerce de Lyon.

7. Appendix

7.1. Dimension of the ROTAX 912S engine propeller-shaft

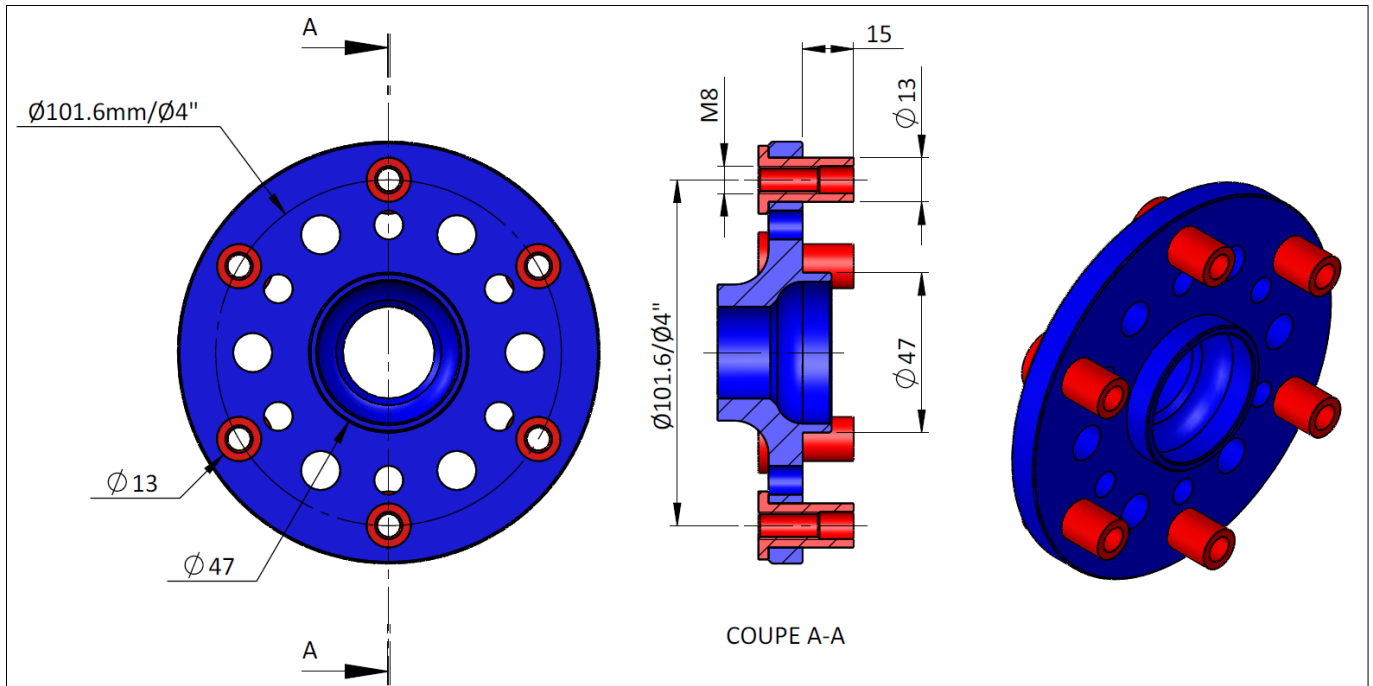

7.2. Moment of inertia of the SWIRL propeller

Type of propeller	Diameter (mm)	Inertia (kg.cm ²)
Two-blade Inconel SWIRL Left & Right	1730	2896
Three-blade Inconel SWIRL Left & Right	1730	4253



7.3. Operating limitation of the SWIRL propeller

Designation	Maximum engine power	Maximum rotational speed
Two-blade Inconel SWIRL propeller, Right & Left	65 hp	3300 rpm
Three-blade Inconel SWIRL propeller, Right & Left	100 hp	3300 rpm
Three-blade Inconel SWIRL-R propeller, Right & Left	120 hp	3300 rpm

7.4. Identification marking of the propeller

7.4.1. Manufacturing label

As the propeller is dismountable, each component (blade and half-hub) has a manufacturing traceability label which identifies the component and specifies its own serial number:

SWIRL Left blade (All version)	SWIRL Right blade (All version)	Half-hub (2 and 3-blade)
		

7.4.1. Propeller label (for LSA certified version)

At the end of the manufacturing, a 2nd label - the propeller label - is placed on each components of the propeller (blade and half-hub) with the following information:

1st line: Part number of the propeller model

Two-blade (2) or Three-blade (3)

Left (G) or Right (D)

Reinforced structure (R) and/or Inconel leading edge (I)

Diameter in mm

2nd line : Propeller data









Serial number of the propeller (not only the component)

Value of the static balancing of each blade of the prop

P/N: H-SW_3-D-R_I-1730

S/N: XXXX EQ-003: XX

Here is an example for each of the six versions propeller possible:

Propeller version	Label	Propeller version	Label
Two-blade Inconel SWIRL propeller, Right		Three-blade Inconel SWIRL propeller, Right	
Two-blade Inconel SWIRL propeller, Left		Three-blade Inconel SWIRL propeller, Left	
Two-blade Inconel SWIRL-R propeller, Right		Three-blade Inconel SWIRL-R propeller, Right	
Two-blade Inconel SWIRL-R propeller, Left		Three-blade Inconel SWIRL-R propeller, Left	

7.5. Technical folder of the CARBONE FORGÉ® propeller hub

7.5.1. Comparison of Carbone Forge® hub/Forged aluminum hub

The objective of these tests is to evaluate the potential of half-hub carbon composite manufactured with CARBONE FORGÉ® process, comparing different half-hubs made with different types of aluminum.

PARTS AND MATERIALS

4x CARBONE FORGÉ® HALF HUBS



Produced in carbon fiber pre-impregnated class 180 type aircraft.

6x ALUMINIUM HALF HUBS



- AS 7 G06 with heat treatment 1: parts n° 1 / 2
- AS 7 G06 with heat treatment 2: parts n° 3 / 4
- AS 10 S8 G without heat treatment: parts n° 5 / 6

WEIGHT PARTS

Part n°	Aluminum (g)	Carbone Forgé® (g)
1	537	270
2	509	272
3	520	268
4	-	270
5	528	
6	525	

Carbon half-hub weights are typically half the weight of aluminum parts.

Very low weight variation of the CARBONE FORGÉ® parts.

TESTING PROCEDURE

1st TEST: Tension (up to about 15 kN), then compression (up to about 70 kN) of the half-hub along its symmetry axis

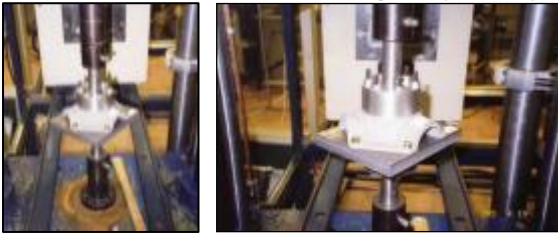

2nd TEST: Application of a tension along an axis inclined relative to the axis of symmetry of the part



For both cases, the results in terms of rigidity and apparent fracture loads are operated. The capacity load cells is limited, the test can reach the breaking part in most cases. In addition, disruptions of screw parts on the equipment during testing were repeatedly produced.

3rd TEST: Compression along the axis of symmetry of the half-hub to 100kN

The parts were equipped with strain gauges on their flat flange to directly obtain the local stress state.

RESULTS

1st TEST: No damage or cracks observed on both parts in aluminum or composite. Note that the tensile strength of carbon parts is comparable to those obtained with aluminum alloys. However, given the significantly lower weight parts carbon, the specific values are much higher.

2nd TEST: The carbon parts show the same or a higher stiffness than the aluminum parts. Except for the aluminum sample No. 1, the tensile strengths are virtually identical. The break seems to be less fragile parts CARBONE FORGÉ®. The spread occurs by delamination of the material around the holes.

Part n°	Weight (g)	Tension (N/mm)	Tension (N/mm/g)	Compression (N/mm)	Compression (N/mm/g)
ALUMINIUM HALF-HUB					
2	509	29400	58	55500	109
6	525	27800	53	58800	112
CARBONE FORGÉ® HALF-HUB					
3	268	28600	107	50000	186
4	270	23330	86	52600	195

Parts n°	Weight (g)	Tension (N/mm)	Tension (N/mm/g)	Rupture (kN)	Rupture (N/g)
ALUMINIUM HALF-HUB					
1	537	7410	13.8	>43.9	-
5	528	7410	14	37.4	71
CARBONE FORGÉ® HALF-HUB					
1	270	9610	35.6	40.5	150
2	272	8000	29.4	38.9	143

3rd TEST: Compression strain gauges.

Unit constraint: $1\mu\text{def} = 10^{-6}$

Parts n°	Strength / Stiffness (N/ μdef)
Aluminum – part n°2	111
Aluminum – part n°3	83
Carbon – part n°5	47

CONCLUSION

The process CARBONE FORGE® is very suitable for the manufacture of engineered components, such as half-hub, with excellent mechanical and following the directions of the reinforced structure. The mechanical properties examined CARBONE FORGE® hubs are comparable to those obtained from forged aluminum alloys, for similar size pieces, and therefore better performance specific, with the lower density material (1.5 against 2.9).

7.5.2. Temperature resistance – DUC Carbon Half-hub

The tests of temperature resistance were carried out on a sample of DUC propeller half hub manufactured with the Forged Carbon process in HEXCEL COMPOSITES laboratory.

Material: Layer UD carbon fiber pre-impregnated class 180 type aircraft

Procedure: Measurements of glass transition temperature Tg were performed on DSC and DMA devices.

Results:

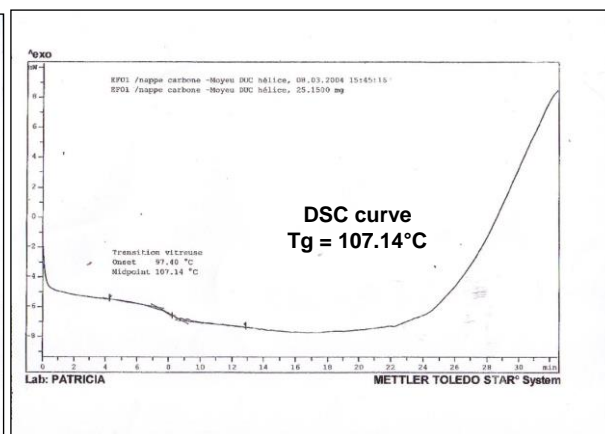
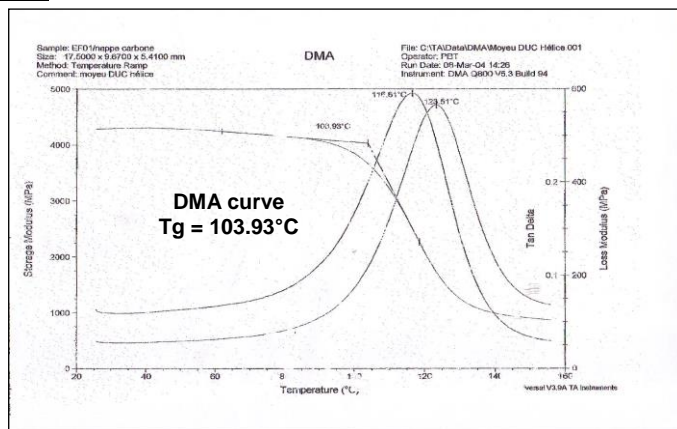

7.6. Technical folder of the Standard and Inconel SWIRL blade

7.6.1. Centrifugal force solicitation of the SWIRL blade according the engine/gear box

Calculation of the centrifugal force: $F = \frac{M \times V^2}{R_G}$

RPM_{max} : Maximum engine speed (RPM) Ø_{hélice} : Propeller diameter (mm)

F : Centrifugal force (N)

RPM_{red} : Propeller rotation speed (RPM) G_{pale} : Gravity center position on the blade (mm)

F_{FoS(2)} : Centrifugal force with factor of safety 2 (RPM)

Red. : Gear box ratio

R_G : Radius of the gravity center of the blade (mm)

V : Linear speed in tip blade of the propeller (m/s)

M : Weight of the blade (kg)

Standard SWIRL blade

MOTEUR		HELICE					FORCE CENTRIFUGE			
Type	RPM _{max} (tr/min)	Red.	RPM _{red} (tr/min)	Ø _{hélice} (mm)	G _{pale} (mm)	R _G (mm)	V (m/s)	M (kg)	F (N)	F _{FoS(2)} (N)
MOTEUR 4 TEMPS										
ROTAX 912	6000	2.273	2640	T-Ø1660	248	285	78.74	0.936	20 363	40 726
ROTAX 912S	6000	2.43	2469	T-Ø1730	248	285	73.65	0.952	18 121	36 243
ROTAX 914	6000	2.43	2469	T-R Ø1730	253	290	74.95	1.031	19 969	39 939
JABIRU	3300	1.00	3300	T-Ø1520	215	252	87.04	0.877	26 366	52 732
MOTEUR 2 TEMPS										
ROTAX 582	6800	2.58	2636	B-Ø1660	248	285	78.62	0.936	20 301	40 602
ROTAX 582	6800	2.62	2595	B-Ø1660	248	285	77.42	0.936	19 686	39 372
ROTAX 582	6800	3.00	2267	T-Ø1730	248	285	67.61	0.952	15 271	30 542
ROTAX 582	6800	3.47	1960	T-Ø1730	248	285	58.46	0.952	11 415	22 829
ROTAX 582	6800	4.00	1700	T-Ø1730	248	285	50.71	0.952	8 590	17 180

Inconel SWIRL blade

MOTEUR		HELICE					FORCE CENTRIFUGE			
Type	RPM _{max} (tr/min)	Red.	RPM _{red} (tr/min)	Ø _{hélice} (mm)	G _{pale} (mm)	R _G (mm)	V (m/s)	M (kg)	F (N)	F _{FoS(2)} (N)
MOTEUR 4 TEMPS										
ROTAX 912	6000	2.273	2640	T-Ø1660	252	289	79.85	0.959	21 156	42 312
ROTAX 912S	6000	2.43	2469	T-Ø1730	263	300	77.53	0.975	19 536	39 072
ROTAX 914	6000	2.43	2469	T-R Ø1730	261	298	77.01	1.054	20 978	41 956
JABIRU	3300	1.00	3300	T-Ø1520	220	257	88.77	0.900	27 594	55 189
MOTEUR 2 TEMPS										
ROTAX 582	6800	2.58	2636	B-Ø1660	252	289	79.73	0.959	21 092	42 183
ROTAX 582	6800	2.62	2595	B-Ø1660	252	289	78.51	0.959	20 453	40 905
ROTAX 582	6800	3.00	2267	T-Ø1730	263	300	71.17	0.975	16 463	32 927
ROTAX 582	6800	3.47	1960	T-Ø1730	263	300	61.53	0.975	12 306	24 611
ROTAX 582	6800	4.00	1700	T-Ø1730	263	300	53.38	0.975	9 261	18 521

7.6.2. Breaking test of the SWIRL blade

The complete failure of the SWIRL blade could not be obtained by a tensile test in the axis of the blade because of the limit of the facility. Thus, to estimate the value of the axis break in a tensile test static skewed by 32 ° is achieved. The rupture occurred at the foot of the shoulder blade. We can consider that the failure of the blade along the axis is about twice the break value to 32 ° because in that position, only half foot blade is in contact with the assembly.

Static pulling of the blade along the axis	Delaminating at 58 000 N
Static pulling of the blade at 32° to the axis	Break point at 48000 N
Estimated break value to pulling of the blade	Calculated break point at 96 000 N



7.6.3. Centrifugal force test under the CS-P350 specification

The test of centrifugal force propeller is defined by the certification specification of propeller CS-P 350. Its objective is to demonstrate its compliance with the certification specification of propeller (CS-P) defined by the European Aviation Safety Agency (EASA). After the test, the propeller must show no evidence of fatigue, failure or permanent deformation that would result in a major or hazardous effect on the propeller. It is considered that this test is used to validate the mechanical strength of the propeller, i.e. to confirm the manufacturing process thereof. This test is conducted with the propeller SWIRL Inconel Ø1520mm a sollicitation representative of its mounting on the engine JABIRU. Being the most detrimental to the test, this configuration was chosen. Thus, the test is used to validate all configurations below that selected. In addition, all using the same propeller design and the same manufacturing technology will be considered consistent with values similar or lower than those of the test.

Procedure: Applying a charge for 1 hour = 2 x maximum centrifugal load = 55 189 N

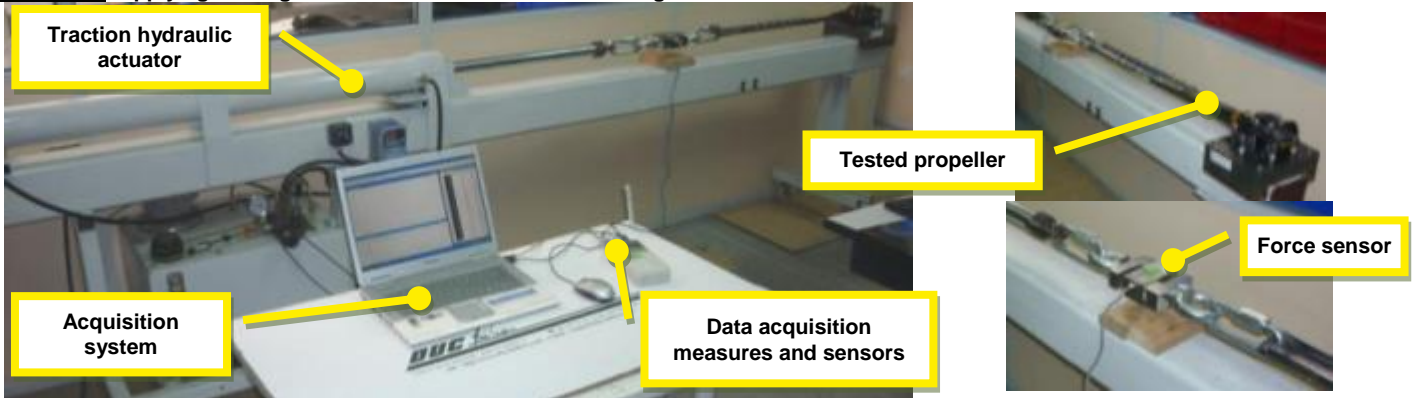

Results: Obtained by visual analysis of comparative sections of the internal structure of the products tested.

No external damage was observed during and after the centrifugal load test. Comparative analysis of the blade:

- Good compaction and homogeneity of carbon/epoxy layers in intrados and extrados, and the blade foot inside the ring (a few tiny air bubbles but acceptable)
- Liaison homogeneous of extrados and intrados skin located on the leading edge and trailing edge
- No visible pores or clusters of resin
- Exterior profiles identical blades
- Good adhesion between the skin and the inner core
- Good cohesion of the Inconel reinforcement of the leading edge on the structure
- Good densification of inner core

As for the visual analysis of sections of the hub:

- Good compaction and homogeneity of carbon/epoxy layers
- Good position and tension of the fiber in the room
- No deformation, wear, surface delamination observed in and around the holes
- No visible porosity

The centrifugal load test according to specification CS-P 350 leads to the conclusion that the propeller is properly sized and is designed to operate on an installation or less JABIRU engine, seeking the blade in a centrifugal force of 27 594 N.

7.6.4. Bending fatigue test of DUC blade

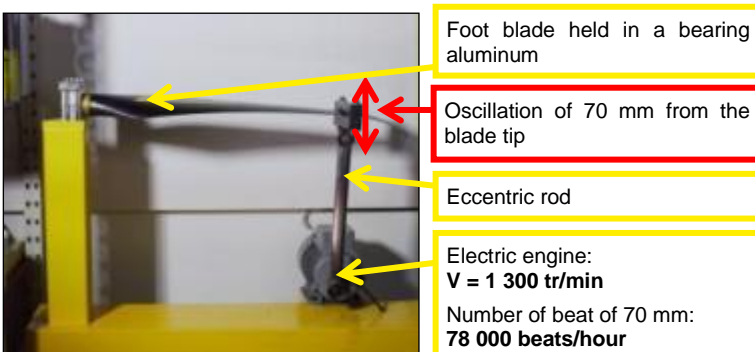

DUC blades suffered a bending test for 30 hours or 2 340 000 cycles of oscillation of 70mm.

Following these requests, these blades have been tensile test and the results showed no change in resistance of structure.

7.7. Declaration of conformance of the SWIRL propeller

7.7.1. Design and Construction

The propeller SWIRL was designed to be adapted to the applications described in section 3. Every design features are reliable and mastered by DUC Hélices company.

The materials used in the propeller were selected for their technical properties to be conforms to the definition of the propeller and durable during the propeller life.

About the ground adjustable system, the design allows a fine and careful setting of the propeller blade pitch. Also, the system is robust to not change during normal and emergency operation of the propeller and also after many settings.

Definition SWIRL propeller conforms to withstand the stresses of operation on all its lifetime. Refer to the centrifugal force test (section 7.6.3), breaking test (section 7.6.2) and next section **7.7.2. Tests and Inspections**.

7.7.2. Tests and Inspections

The SWIRL propeller completes the tests and inspections described below, without failure or malfunction.

Strength Testing:

Proof of strength is presented in section **7.6.3. Centrifugal force test under the CS-P350 specification**.

The blade root and blade retention system were tested for 1 hour at a load level equal to two times the centrifugal load that would be generated by the blade weight at maximum rated rotational speed. This test was done in a static pull test.

Endurance Testing:

The SWIRL propeller conforms to endurance test of each application exposed in section 3.

Teardown Inspection:

After completion of each test described above, the tested SWIRL propeller was completely disassembled and each propeller parts were inspected. No failure or crack was found.

Propeller Adjustments and Parts Replacements:

During the tests and inspections carried out, no parts have to be repaired or replaced. All propeller parts resisted the tests and were conform after inspections.

7.7.3. Design Control

The SWIRL propeller was design on CAD software. All the CAD files and 2D drawings are stored in the Design Office of DUC Hélices Company, as the definition of the SWIRL configurations. All the technical data (dimensions, materials and processes) are saved in manufacturing procedure. Also, a copy all these data are archived out of the company.

7.7.4. Quality Assurance

DUC Hélices Company is ISO 9001:2008 certified for its management of the quality system, which ensures manufactured propellers maintain conformity to the established design. Refer to page 2.

7.7.5. Certification of Conformity for ASTM F2506-10

"ASTM F2506-10 is the standard specification for design and testing of fixed-pitch or ground adjustable for Light Sport Aircraft propellers.

DUC Hélices Company declares that the SWIRL propeller complies with the ASTM F2506-10 standard and after verification, it responds every requirement."



Mr. Vincent Duqueine
Manager

21/03/2017

DUC Hélices Propellers
contact@dco-helices.com - www.dco-helices.com
Aérodrome de Villefranche-Tarare
69620 FRONTENAS - FRANCE
Tél. : +33 (0)4 74 72 12 69
SIRET : 413 269 887 00035

DUC Hélices Propellers

Aérodrome de Villefranche-Tarare (LFHV)
289 Avenue Odette & Edouard DURAND
69620 FRONTENAS - FRANCE

Phone: + 33 (0)4 74 72 12 69 - Fax: +33 (0)4 74 72 10 01

E-mail: contact@duc-helices.com - www.duc-helices.com

After sales services : service.technique@duc-helices.com



ISO 9001:2008
Certified Company

INFO
PILOTE



Protéger votre hélice !

Housse néoprène - Référence commerciale : 01-80-002

INFO
PILOTE



Faites des économies !

Dégraisser votre hélice permet de

DIMINUER LA CONSOMMATION

en améliorant les performances

Référence commerciale : 01-80-003

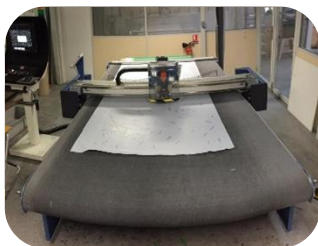

Data and pictures included in this instruction manual are exclusively property of DUC Hélices Company. Any part of this manual can be reproduced or transmitted in any form with any means, electronic or manual, for any reason, without written approval of DUC Hélices Company.